

# ACFF-1025

## LTE Band 41 Bandpass Filter



### Data Sheet



Lead (Pb) Free  
RoHS 6 fully  
compliant

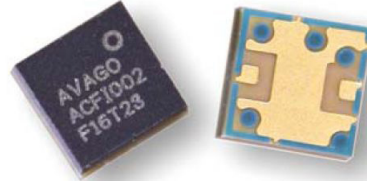

### Description

The Avago ACFF-1025 is a highly miniaturized LTE Band 41 (2496 – 2690 MHz) bandpass filter combined with a WLAN/Wi-Fi band reject filter.

The ACFF-1025 is designed to operate in WiMAX transceiver applications which coexist with WLAN, Wi-Fi and/or Bluetooth transmitters.

The ACFF-1025 is designed with Avago Technologies' innovative Film Bulk Acoustic Resonator (FBAR) technology, which makes possible ultra-small, high-Q filters at a fraction of their usual size. The excellent power handling capability of FBAR bulk-mode resonators supports the high output power levels used in mobile communications applications, while adding virtually no distortion.

The ACFF-1025 also utilizes Avago Technologies' advanced Microcap bonded-wafer, chip scale packaging technology. This process allows the filter to be assembled into a molded chip-on-board module with an overall size of 2.5 x 2.5 mm and height of 1.0 mm.

### Functional Block Diagram

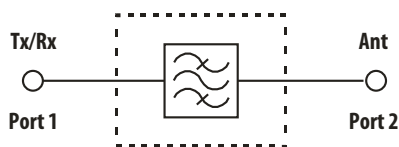

### Features

- 50  $\Omega$  Input/Output
- WLAN/Wi-Fi Reject Notch
- Miniature Size
  - 2.5 x 2.5 mm
  - 1.0 mm Height
- High Power Rating
  - 33 dBm Abs Max Power
- Extended Operating Temperature Range
  - 40 to +85°C
- Environmental
  - RoHS 6 Compliant
  - Halogen free
  - TBBPA Free

### Specifications

- Performance, - 20 to +85°C
  - LTE Band 41 Insertion Loss
    - 2496.5 – 2502 MHz: 4.0 dB Max
    - 2502 – 2689.25 MHz: 3.8 dB Max
  - Cell Rx Band Rej: 30 dB Min
  - PCS Rx Band Rej: 20 dB Min
  - WLAN/Wi-Fi/BT Rej: 20 dB Min

### Applications

Bandpass filter for cellular base station receivers and indoor small cell applications operating in LTE Band 41.

**ACFF-1025 Electrical Specifications** <sup>[2]</sup>,  $Z_0=50\ \Omega$ ,  $T_C$  <sup>[1]</sup> as indicated

Symbol	Parameter	Units	- 40°C			- 20°C			+25°C			+85°C		
			Typ <sup>[3]</sup>	Min	Typ <sup>[3]</sup>	Max	Min	Typ <sup>[3]</sup>	Max	Min	Typ <sup>[3]</sup>	Max		
<b>Ant (Tx/Rx) Port to Tx/Rx (Ant) Port</b>														
S21 (S12)	Insertion Loss in Band 41 2496.50 – 2502.00 MHz 2502.00 – 2689.25 MHz	dB	2.1 2.1	2.1 2.3	4.0 3.8	2.2 2.5	3.5 3.5	2.3 2.7	4.0 3.4					
S21 (S12)	Insertion Loss Ripple (p-p) in Band 41 (2502.0 – 2689.25 MHz)	dB	0.7	0.8	2.0	0.8	2.0	1.0	2.0					
S21 (S12)	Attenuation in Cell Tx Band (824 – 849 MHz)	dB	57	35	57	35	57	35	57					
S21 (S12)	Attenuation in Cell Rx Band (869 – 894 MHz)	dB	54	30	54	30	54	30	53					
S21 (S12)	Attenuation in GPS Band (1574.4 – 1576.4 MHz)	dB	34	30	34	30	34	30	34					
S21 (S12)	Attenuation in PCS Rx Band (1930.5 – 1989.5 MHz)	dB	44	20	44	20	43	20	43					
S21 (S12)	Attenuation in WLAN/Wi-Fi/ Bluetooth Bands 2400 – 2468 MHz 2468 – 2473 MHz	dB	45 45	30 20	45 49	30 20	45 48	30 –	45 30					
S21 (S12)	Attenuation in Band 41 2nd Harmonic Band (4993 – 5379 MHz)	dB	28	21	28	20	28	20	28					
S21 (S12)	Attenuation in Band 41 3rd Harmonic Band (7489 – 8068 MHz)	dB	12	8	12	8	13	8	13					
S11	Return Loss (SWR) of Ant Port 2496.5 – 2689.25 MHz	dB		8.0	(2.3)	8.0	12 (1.7)	(2.3)	8.0	(2.3)				
S22	Return Loss (SWR) of Tx/Rx Port 2496.5 – 2689.25 MHz	dB		8.0	(2.3)	8.0	17 (1.3)	(2.3)	8.0	(2.3)				

Notes:

1.  $T_C$  is the case temperature and is defined as the temperature of the underside of the filter where it makes contact with the circuit board.
2. Min/Max specifications are guaranteed at the indicated temperature with the input power to the Tx/Rx port equal to or less than +25 dBm over all Tx/Rx frequencies unless otherwise noted.
3. Typical data is the average value of the parameter over the indicated band at the specified temperature. Typical values may vary over time.

## ACFF-1025

### Absolute Maximum Ratings<sup>[1]</sup>

Parameter	Unit	Value
Storage temperature	°C	-65 to +125
Maximum RF Input Power to Tx Port	dBm	+33
Maximum DC Voltage, any Port to Gnd or between ports <sup>[4]</sup>	V <sub>DC</sub>	0

### Maximum Recommended Operating Conditions<sup>[2]</sup>

Parameter	Unit	Value
Operating temperature, T <sub>C</sub> <sup>[3]</sup> , Tx Power ≤ 29 dBm, CW	°C	-40 to +100
Operating temperature, T <sub>C</sub> <sup>[3]</sup> , Tx Power ≤ 30 dBm, CW	°C	-40 to +85

Notes:

1. Operation in excess of any one of these conditions may result in permanent damage to the device.
2. The device will function over the recommended range without degradation in reliability or permanent change in performance, but is not guaranteed to meet electrical specifications.
3. T<sub>C</sub> is defined as case temperature, the temperature of the underside of the filter where it makes contact with the circuit board.
4. Internal DC resistance of ports is approximately a short circuit.

## Applications Information

The Avago ACFF-1025 is an LTE Band 41 (2496 – 2690 MHz) bandpass filter combined with a WLAN/Wi-Fi band reject filter.

The ACFF-1025 is designed to operate in multi-radio system architectures such as illustrated in the simplified diagram in Figure 1. The steep, WLAN/Wi-Fi band-reject characteristic of the ACFF-1025 allows Band 41 transceivers to successfully coexist in close proximity to WLAN, Wi-Fi and/or Bluetooth radios.

Use of Avago's companion Wi-Fi filter in the WLAN transceiver completes the architecture.

**Note:** The ACFF-1025 is not symmetrical. As shown in Figure 1, Port 2 is connected to the system Antenna and Port 1, which is designed for higher power handling, is connected to the Tx/Rx blocks. If either port of the ACFF-1025 is connected to components having a DC voltage present, blocking capacitors should be used.

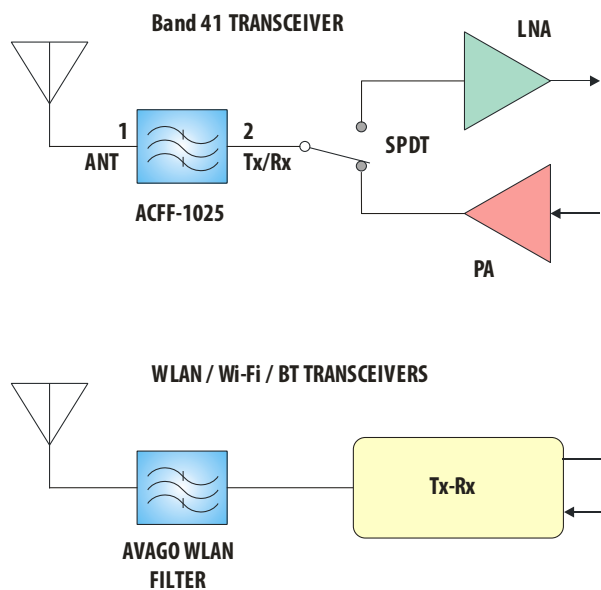

Figure 1. Typical Multi-Radio Application.

## ACFF-1025 Typical Performance at $T_c = 25^\circ\text{C}$

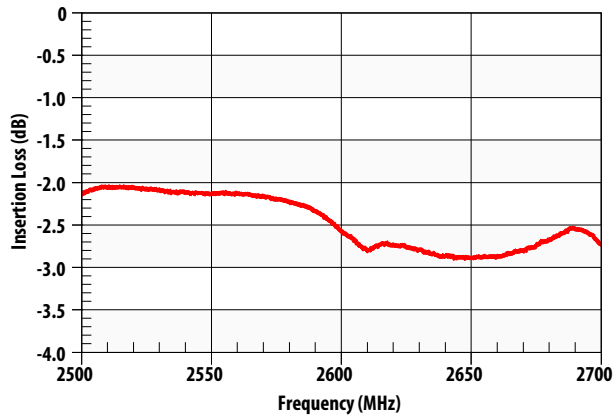

Figure 2. Insertion Loss in Band 41

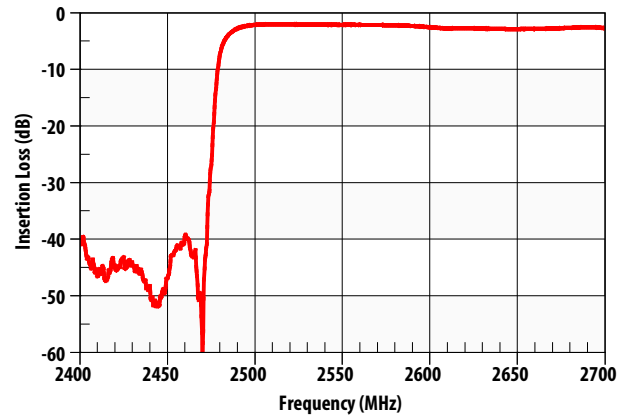

Figure 3. Insertion Loss in WLAN/Wi-Fi/Band 41

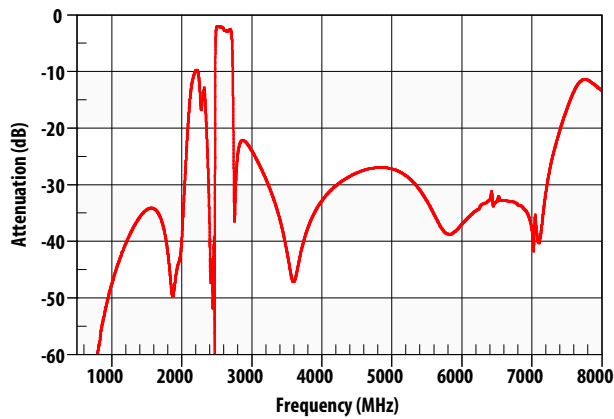

Figure 4. Wideband Insertion Loss

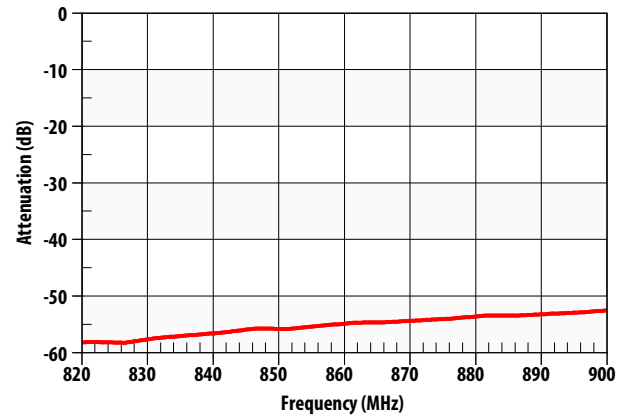

Figure 5. Rejection in Cell Tx-Rx Band

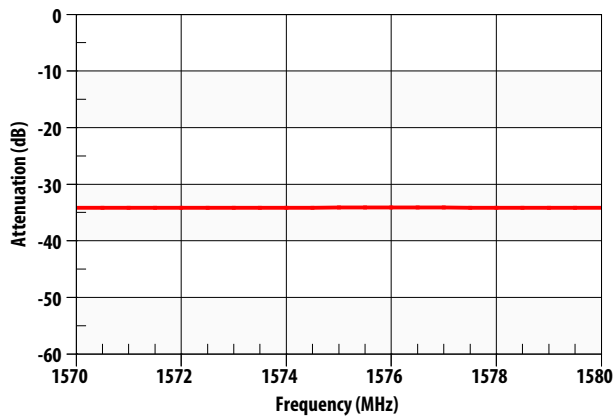

Figure 6. Rejection in GPS Band

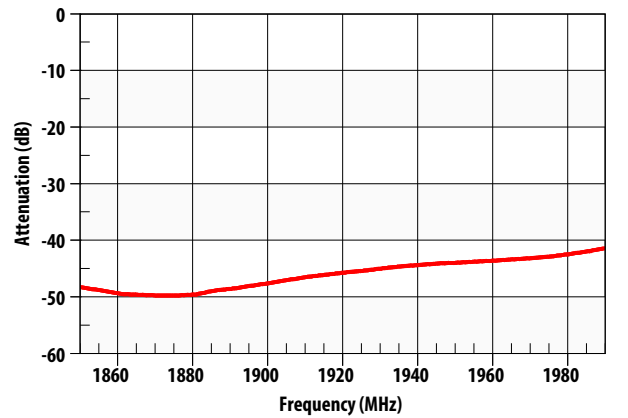

Figure 7. Rejection in PCS Tx-Rx Band

## ACFF-1025 Typical Performance at $T_c = 25^\circ\text{C}$

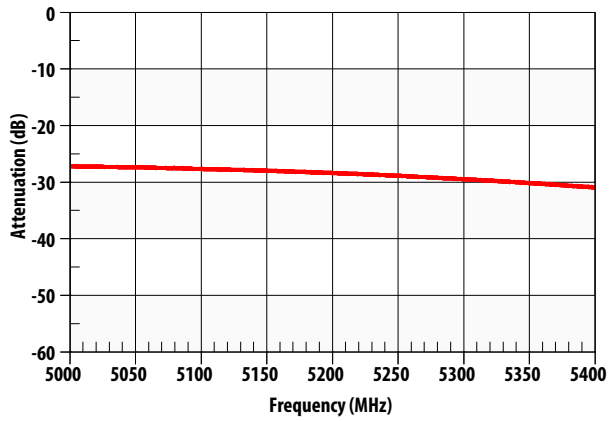

Figure 8. Rejection at Band 41 Second Harmonic

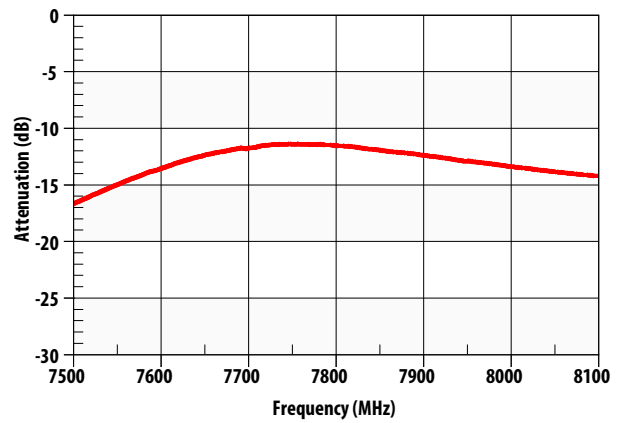

Figure 9. Rejection at Band 41 Third Harmonic

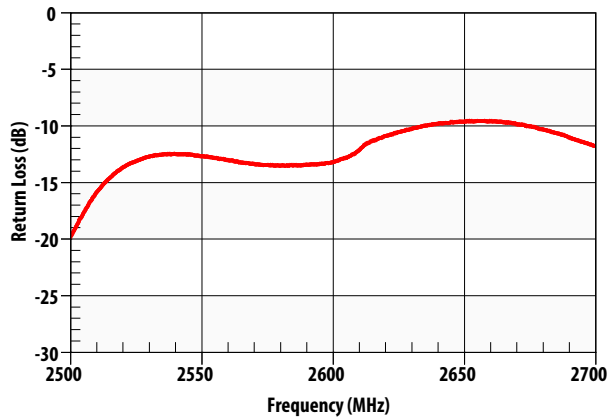

Figure 10. Ant Port Return Loss in Band 41

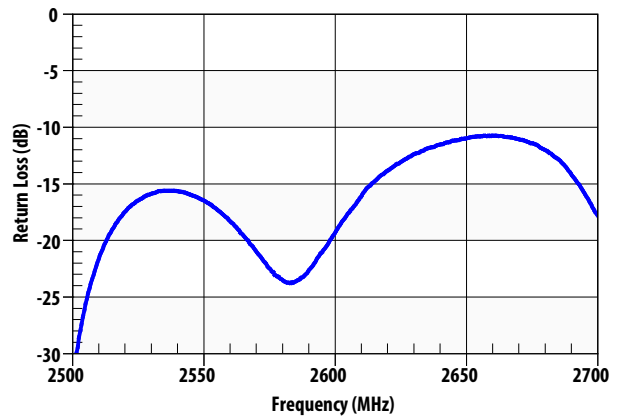

Figure 11. Tx/Rx Port Return Loss in Band 41

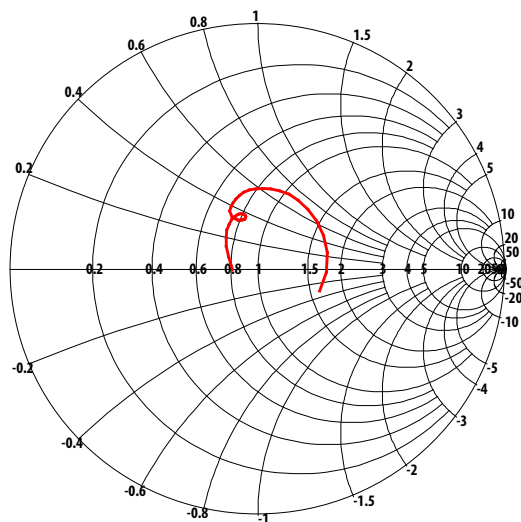

Figure 12. S11 (Ant Port) Impedance in Band 41

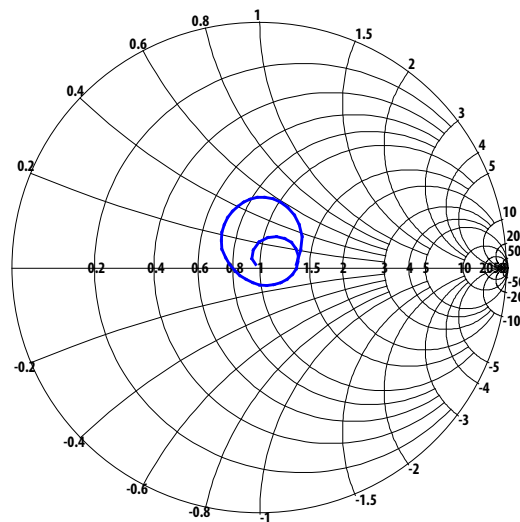

Figure 13. S22 (Tx/Rx Port) Impedance in Band 41

**ACFF-1025 Typical Performance over Operating Temperature Range,  $-40^{\circ}$  to  $+85^{\circ}\text{C}$**   
 Blue =  $-40^{\circ}$ , Magenta =  $-20^{\circ}$ , Green =  $+25^{\circ}$ , Red =  $+85^{\circ}\text{C}$

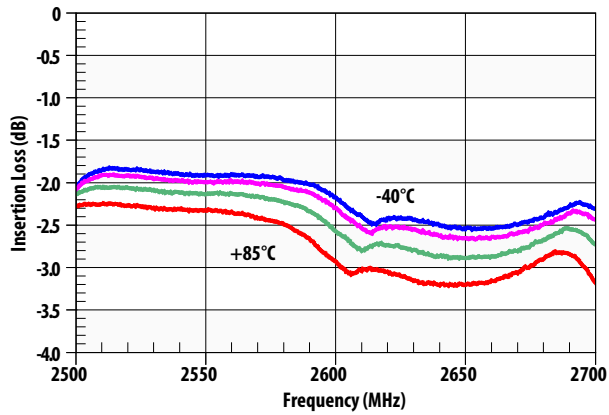

Figure 14. Insertion Loss in Band 41

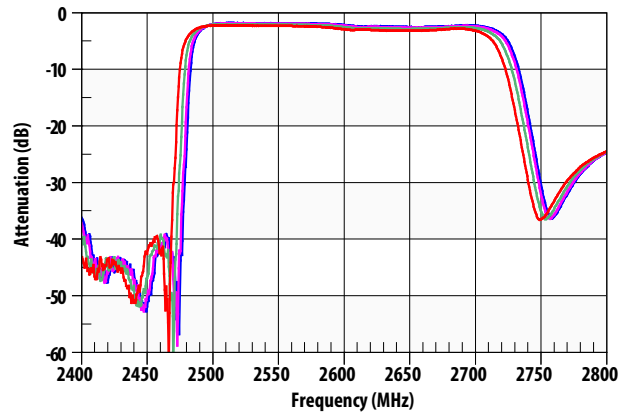

Figure 15. Insertion Loss in WLAN/Wi-Fi/Band 41

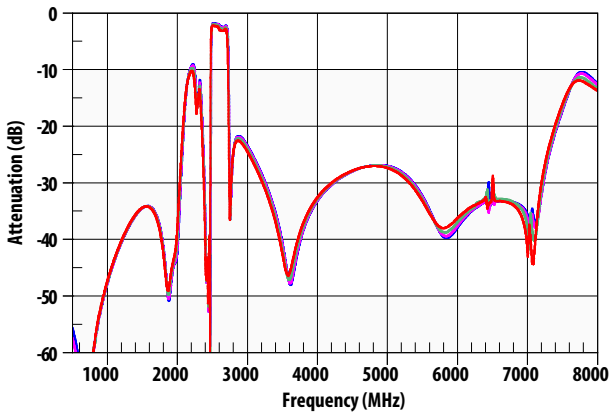

Figure 16. Wideband Insertion Loss

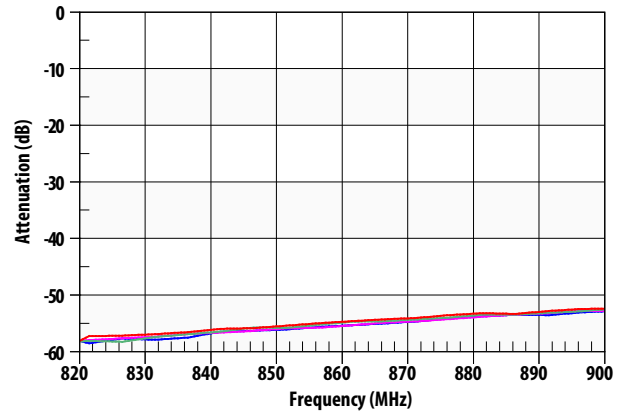

Figure 17. Rejection in Cell Tx-Rx Band

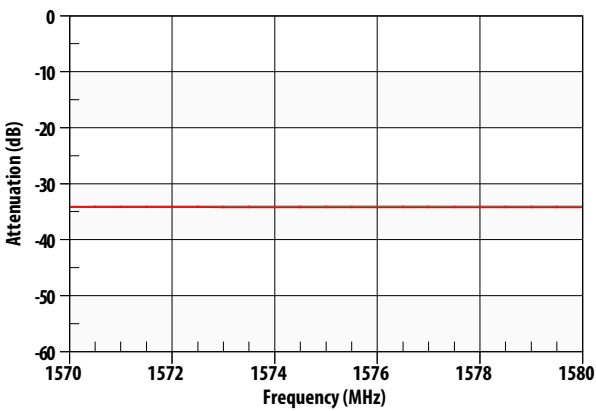

Figure 18. Rejection in GPS Band

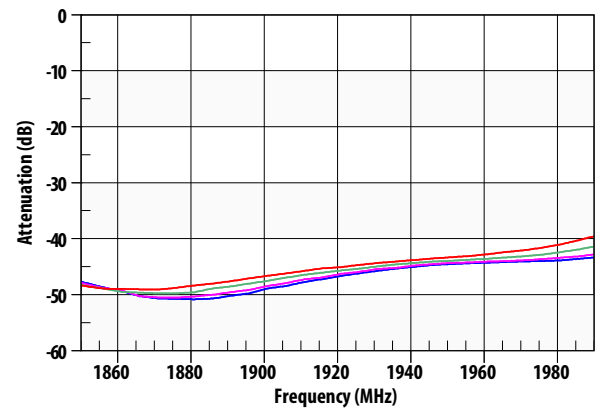
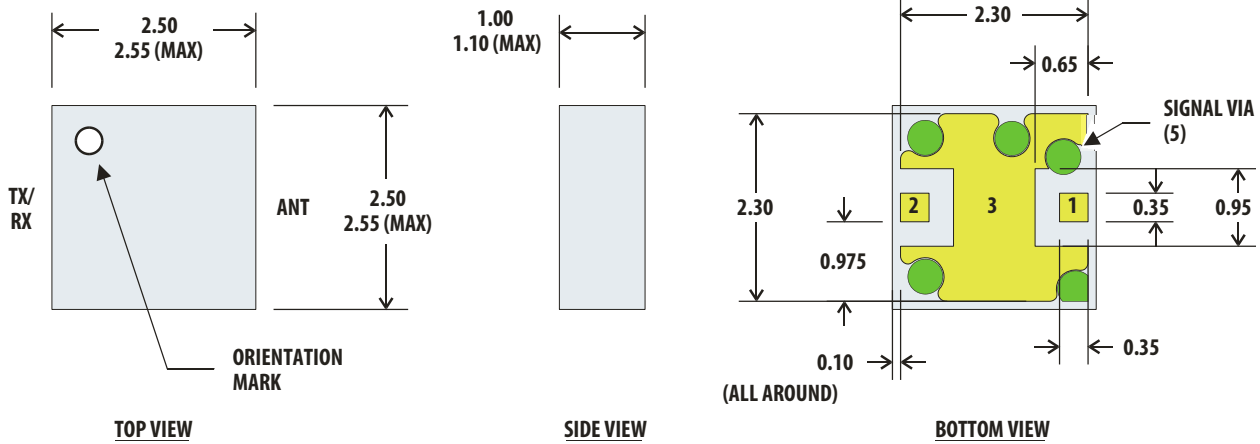

Figure 19. Rejection in PCS Tx-Rx Band

# ACFF-1025



**Notes:**

1. Dimensions in millimeters  
Tolerance: X.X ± 0.1 mm  
X.XX ± 0.05 mm
2. Dimensions nominal unless otherwise noted
3. I/O Pads (2 ea)  
Size: 0.35 X 0.35 mm  
Spacing to ground metal: 0.30 mm
4. Signal Vias (5 ea), Ø 0.15; covered with 0.42 Ø solder mask.  
Shown for reference only. PCB metal under signal via does not need to be voided.
5. Contact areas are gold plated

**Pin Connections:**

- 1 Tx/Rx
- 2 Ant
- 3 Ground

Figure 20. Package Outline Drawing.

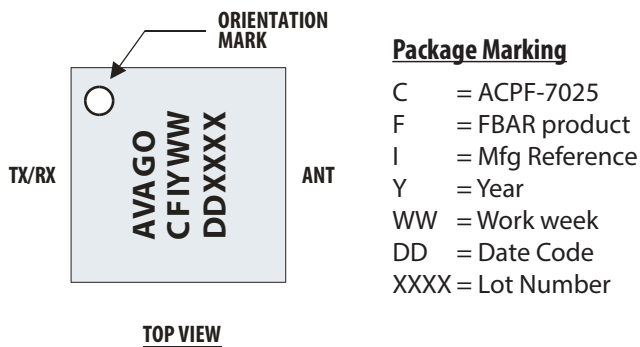

Figure 21. Product Marking and Pin Orientation.

# ACFF-1025

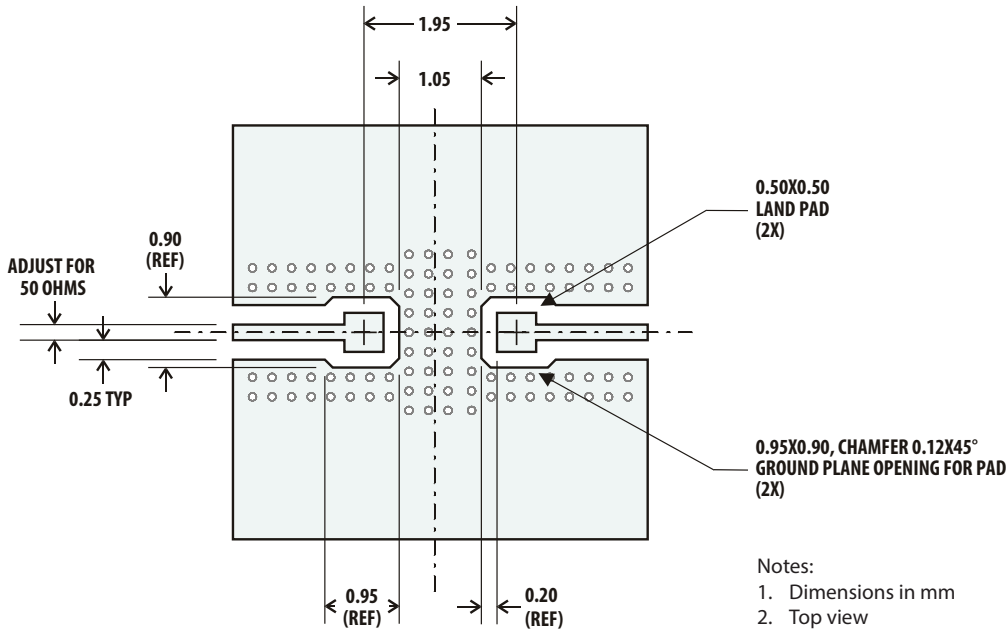

Figure 22. Suggested PCB Land Pattern.

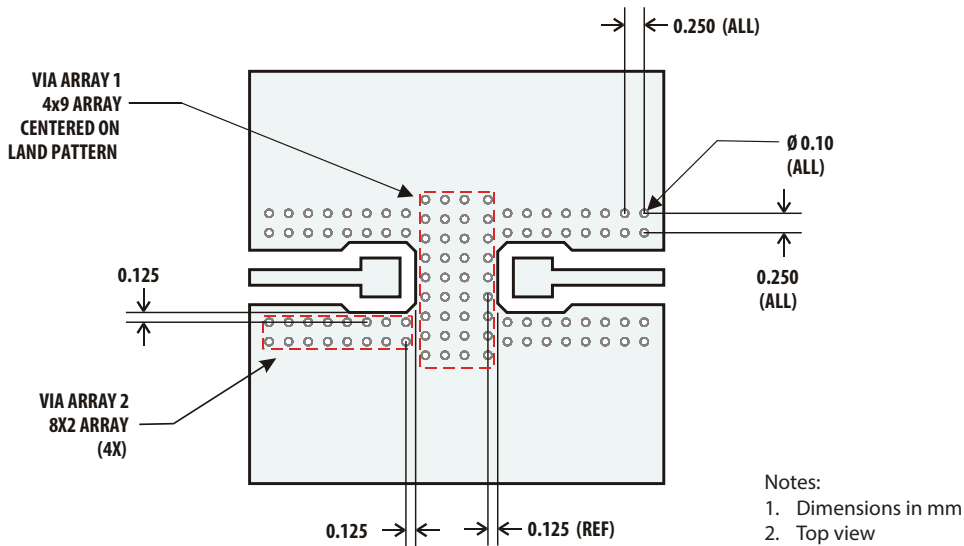

Figure 23. PCB Layout, Via Detail.

A PCB layout using the principles illustrated in the figure above is recommended to optimize performance of the ACFF-1025.

Transmission line dimensions should be adjusted to maintain a  $Z_0$  of 50 ohms.

It is important to maximize isolation between the filter Input and Output ports.

High isolation is achieved by: (1) maintaining a continuous ground plane around the I/O connections and filter mounting area, and (2) surrounding the I/O ports with sufficient ground vias to enclose the connections in a “Faraday cage.”

Ground vias under the ACFF-1025 mounting area also provide heat sinking for the device to minimize shifting of the pass band over temperature.



# ACFF-1025

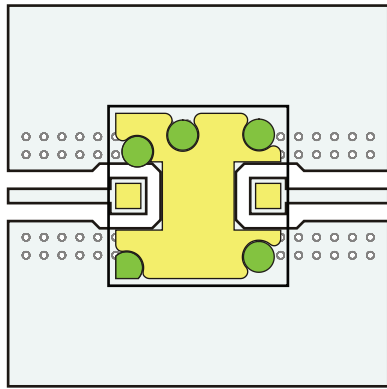

Note:  
1. Top view

Figure 24. ACFF-1025 Superposed on PCB Layout.

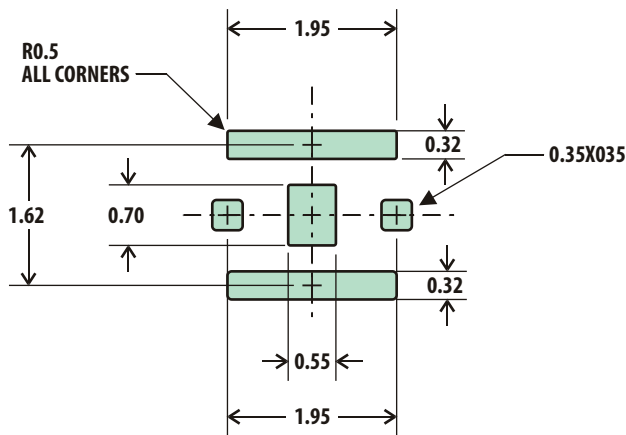

Notes:  
1. Dimensions in mm  
2. Top view  
3. Chamfer or radius all corners 0.05 mm min

Figure 25. Recommended Solder Stencil.

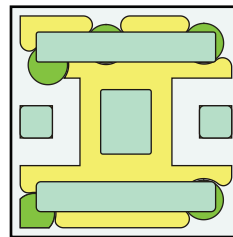

Notes:  
1. Top view  
2. I/O pad apertures match device pad 1:1

Figure 26. Solder Stencil Superposed on ACFF-1025.

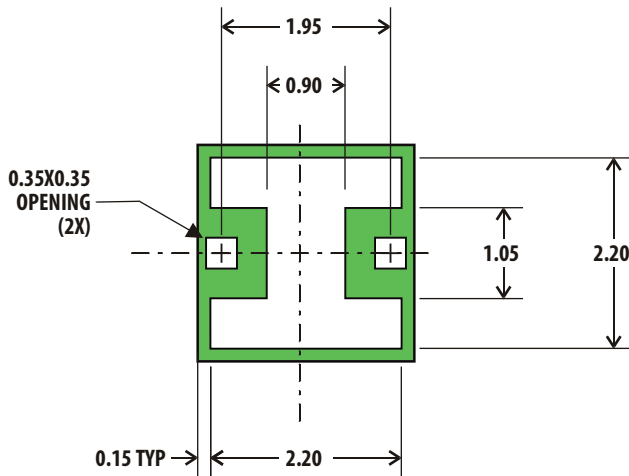

Notes:  
1. Dimensions in mm  
2. Top view

Figure 27. Recommended Solder Mask.

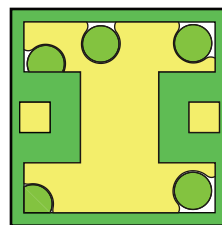

Notes:  
1. Top view  
2. Mask apertures match device pads 1:1

Figure 28. Solder Mask Superposed on ACFF-1025.

**ACFF-1025**

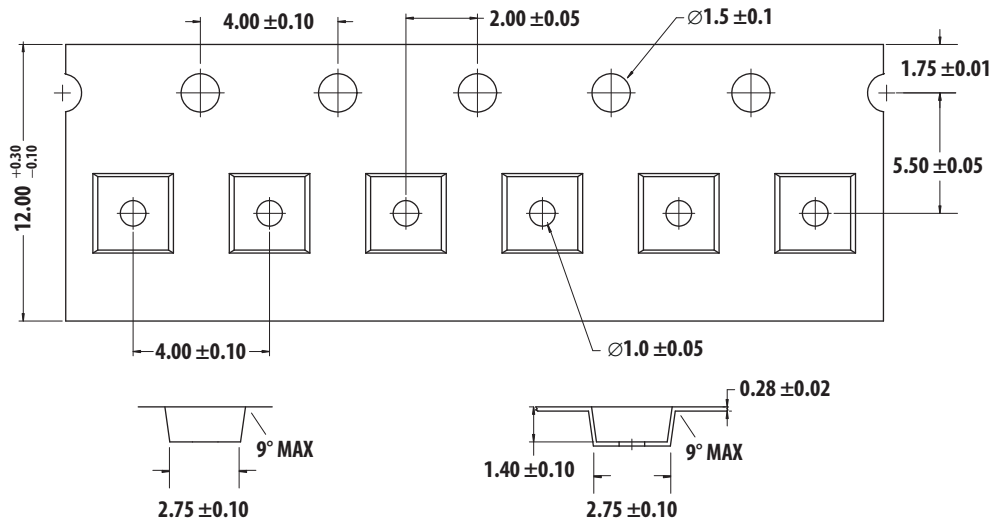

Note:  
1. Dimensions in mm

**Figure 29. SMD Tape Drawing.**

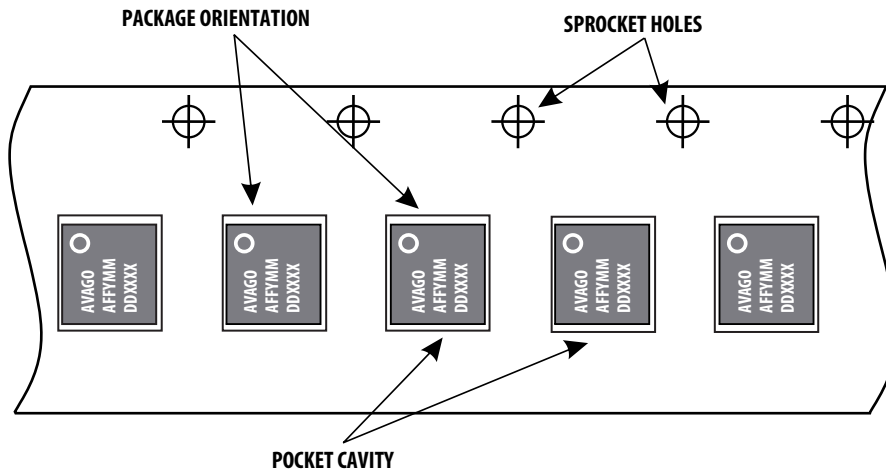

**Figure 30. Unit Orientation in SMT Tape.**

ACFF-1025

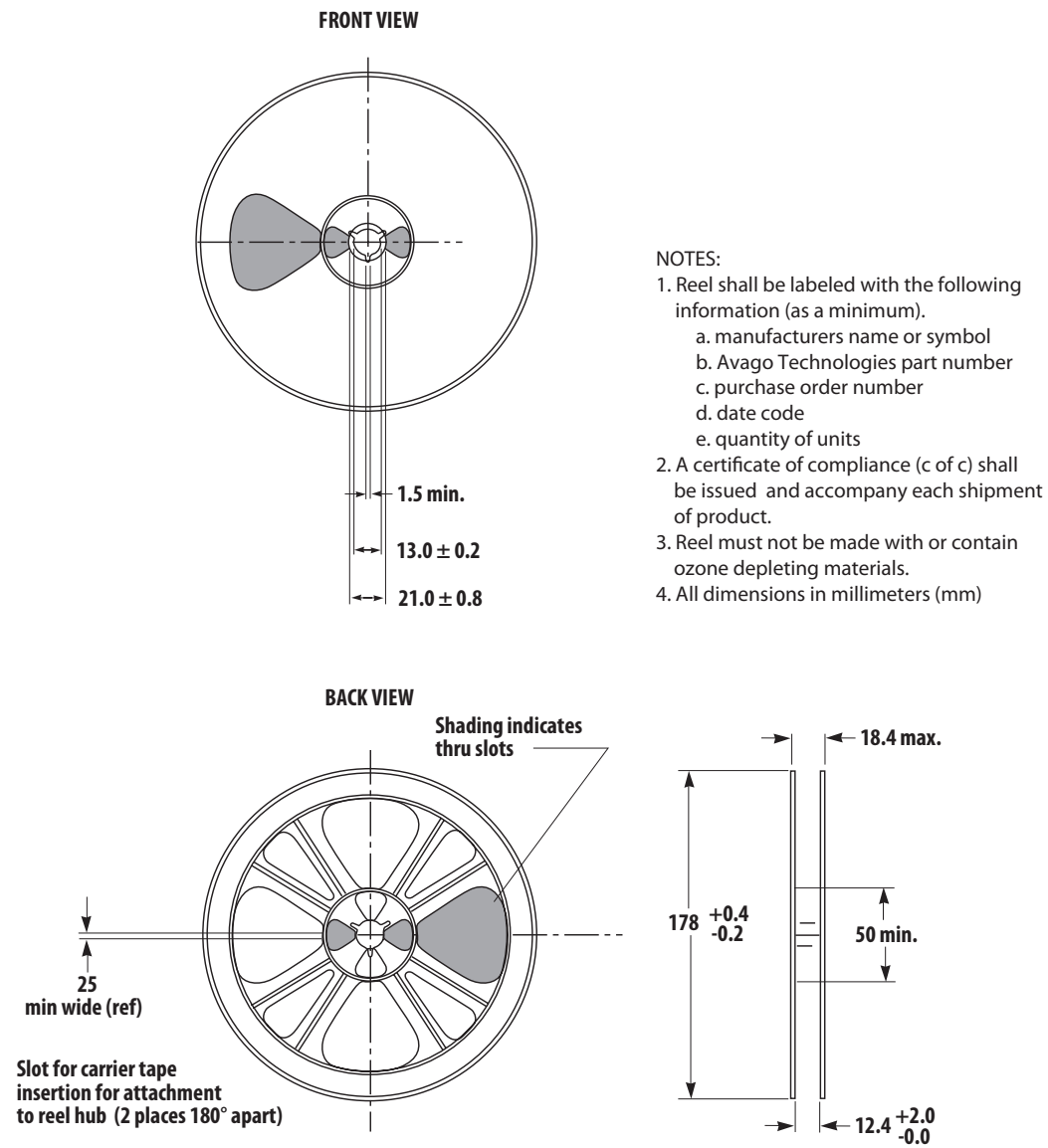

Figure 31. SMT Reel Drawing.

## ACFF-1025

### Package Moisture Sensitivity

Feature	Test Method	Performance
Moisture Sensitivity Level (MSL) at 260°C	JESD22-A113D	Level 3

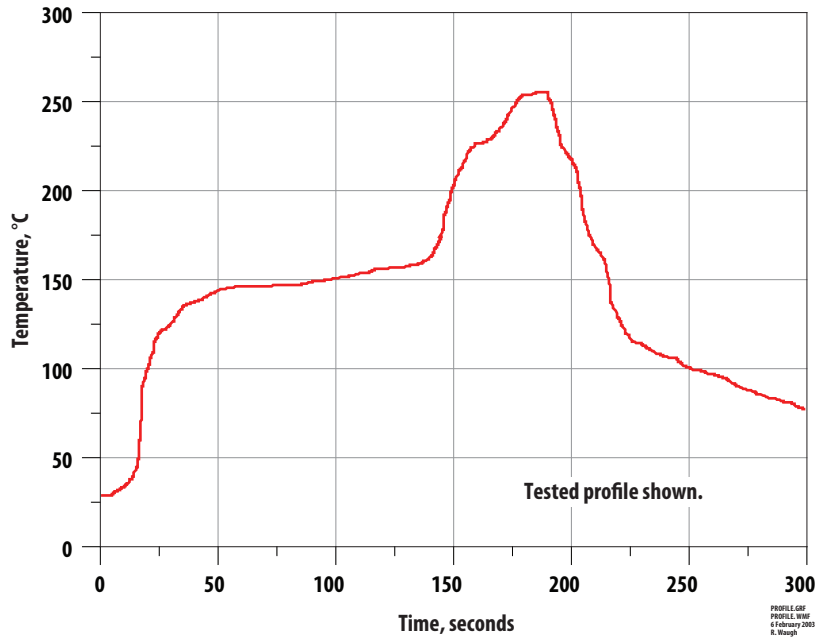

Figure 32. Verified SMT Solder Profile.

### Ordering Information

Part Number	No. of Devices	Container
ACFF-1025-BLK	100	Tape Strip or Anti-static Bag
ACFF-1025-TR1	3000	178 mm (7-inch Reel)

For product information and a complete list of distributors, please go to our web site: [www.avagotech.com](http://www.avagotech.com)

Avago, Avago Technologies, and the A logo are trademarks of Avago Technologies in the United States and other countries. Data subject to change. Copyright © 2005-2013 Avago Technologies. All rights reserved.  
AV02-4302EN - September 24, 2013

**Avago**  
TECHNOLOGIES